

# Research and design of a small electric off-road vehicle battery system

Shiping Deng\*

Wuhan University of Technology, Wuhan, China, 430070

\*Corresponding author e-mail: 2536965183@qq.com

**Keywords:** small electric off-road vehicle, battery, design, thermal simulation

**Abstract.** The battery system is the power source of electric vehicles and has a vital influence on the power performance of the vehicle. This article takes the electric Baja racing car as an example, starting from the design principle, to the selection of specific components, the design of the battery box assembly model, and finally the thermal simulation analysis of the battery module. The design of the battery system of the electric Baja racing car is explained systematically.

## 1. Introduction

According to the rules of the Electric Baja Competition, the drive system of the electric Baja race car is designed to enable it to drive safely on mud, gravel and other off-road roads. The electrical system of the electric Baja racing car can be divided into two parts: strong electricity and weak electricity. The strong current part includes the design and production of the battery box and the power harness of the vehicle; the weak current part includes the design of VCU hardware and software, the debugging of the BMS, and the motor adjustment. The drive system is the heart of the electric Baja racing car and one of the key technologies for the manufacture of the electric Baja racing car. It directly determines the performance of the electric Baja racing car. It is necessary to combine the actual requirements of the electric Baja racing car to study and design the drive system of the electric Baja racing car, so as to maximize the performance of the car.

## 2. Design principle

### 2.1. High voltage drive part

The battery module, battery management system (BMS) and other necessary components are placed in the battery box. The BMS continuously monitors the voltage of each battery through the voltage acquisition line to ensure that the battery voltage is within the specified range. Through the temperature sensor, the temperature of the battery is detected, and the output power of the battery is limited or the output is directly cut off when the temperature is too high to prevent the battery from being burned due to the high temperature during the discharge process and causing an accident[1].

The main positive and main negative of the power battery must be connected to two contactors, and the two contactors must be directly driven by the safety circuit. A maintenance switch needs to be connected in series on the main circuit. When an emergency occurs, the high voltage output outside the battery box can be disconnected by disconnecting the maintenance switch. The main loop current is measured by a current sensor to provide the necessary current information for the SOC.

All electrical systems (low voltage and high voltage) must be properly fused. The rated continuous current of the fuse cannot be higher than the rated continuous current of any electrical components it protects. When the system is overloaded or short-circuited, the fuse can be properly blown to cut off the high-voltage drive system. In addition, a pre-charging circuit must be installed in the electrical system, which can pre-charge the intermediate circuit until the voltage reaches more than 90% of the current battery voltage before the second AIR is closed.

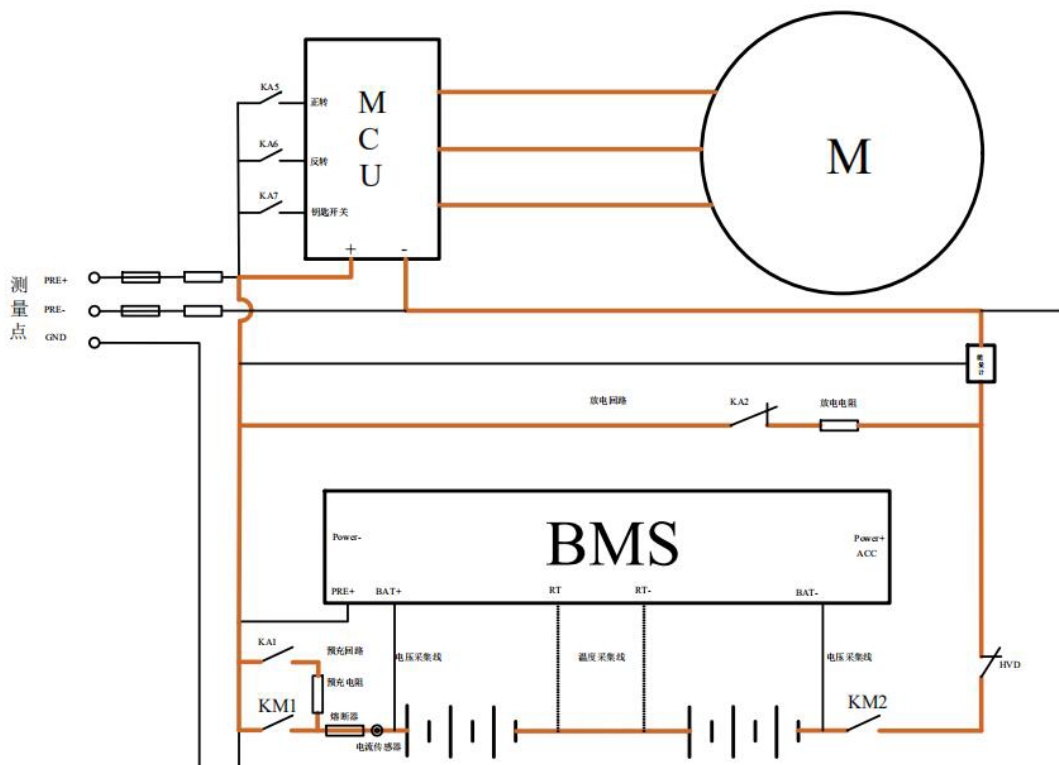

Figure 1. Circuit diagram of high voltage drive part

## 2.2. Low voltage control part

The power supply voltage of the low-voltage control system is 12V, and the high-voltage direct current is reduced to 12V direct current output through an isolated DC/DC step-down module. The main switch of the control system (GLVMS) can cut off the power supply of the control system and directly control the low-voltage control system, including the on and off of the BMS and the motor controller.

The drive system main switch TSMS, brake reliability device BSPD, brake overtravel switch, emergency stop switch and other control switches in the safety circuit ensure that the system can emergency disconnect the two contactors in the event of a failure.

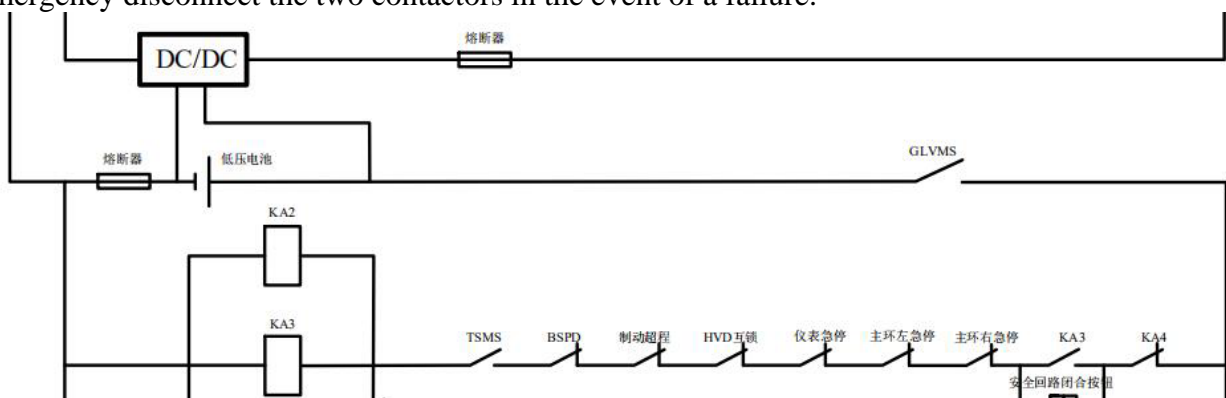

Figure 2. Control system power supply and safety circuit

The battery management system is also powered by a 12V power supply. ACC is the BMS wake-up signal. When ACC receives a high level, the BMS will be awakened to work and perform self-checking.

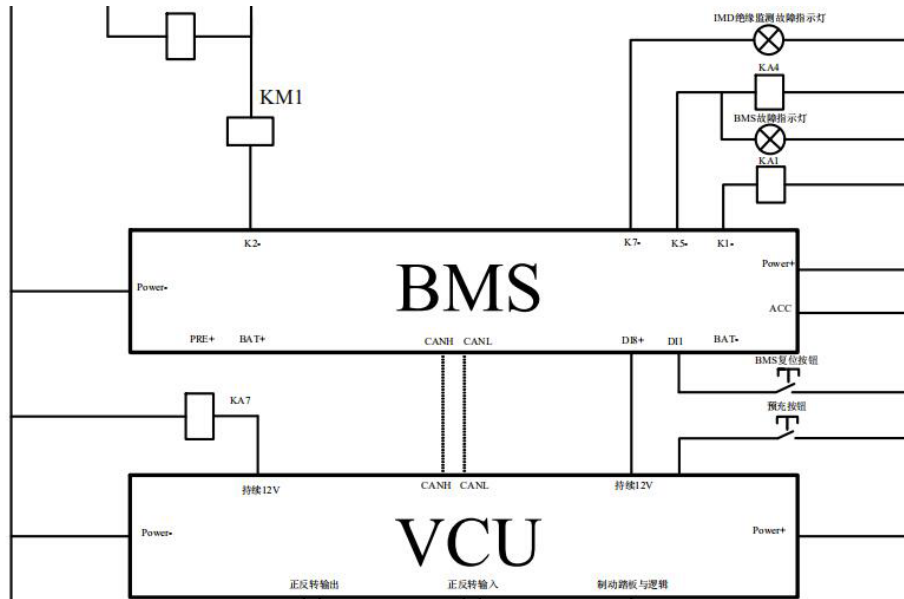

Figure 3. Battery management system control logic diagram

### 3. Component selection

#### 3.1. Power Battery

**3.1.1. Power battery introduction and analysis.** The most important components of new energy electric vehicles are power batteries, motors and energy conversion control systems, and power batteries are part of the higher technical threshold. New energy vehicles have very high requirements for batteries. They must have high specific energy, high specific power, fast charging and deep discharge performance, and require the lowest possible cost and long service life.

Lead-acid batteries, nickel-cadmium batteries, nickel-hydrogen batteries and lithium batteries are currently used in electric vehicles.

The specific classification is as follows:

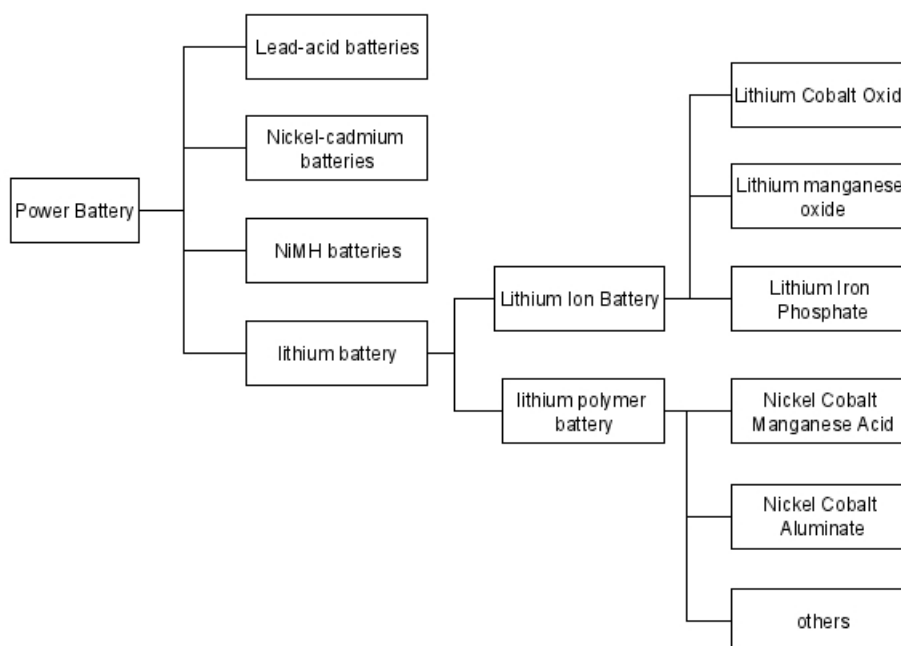

Figure 4. Power battery classification

**3.1.2. Battery selection.** The power battery used in racing requires a higher specific energy and specific power to meet the mileage and power requirements of the electric Baja racing car. At the same time, it is also hoped that the power battery has a long charge-discharge cycle life, high efficiency, good cost performance, and maintenance-free characteristics. The selection of power battery mainly considers battery type, battery pack voltage, power output capacity of the battery pack and total energy storage. Based on the two aspects of battery safety and lightweight considerations, with high battery energy density and large discharge rate as the basic requirements, the 21700 ternary lithium battery cell with an energy density of 5Ah was finally selected [2].

The 21700 power battery refers to a power battery with a diameter of 21.0 mm and a height of 70.0 mm. In recent years, 21700 power battery is a new type of green battery. With the vigorous development of electric vehicles, the high-performance 21700 power battery has become an ideal power battery for electric vehicles. Its working principle and characteristics are very consistent with the requirements of the power battery of electric vehicles. It has become a research hotpot of vehicle batteries.

Table.1. 21700 battery parameters

Project	parameter
Standard capacity	5 Ah
standard	3.7V
Maximum charging voltage	4.2V
Maximum continuous discharge current	15 A (3C)
End of discharge voltage	3.0V

The specific energy of the battery can reach  $300\text{Wh/kg}$  [3], and the discharge rate can reach  $3C$ . It takes into account the requirements of high energy density and large discharge rate, and can meet the requirements of energy storage, stable discharge and high instantaneous power of racing batteries.

**3.1.3. Battery box.** The battery box is used to install the battery system assembly, and the battery modules, battery management system and other components must be reliably placed inside the battery phase. The battery box should have good safety performance and be waterproof and resistant to crushed stones to ensure that the internal battery modules are not interfered by the external environment. Considering the layout of the whole vehicle, it is finally determined that the shape of the battery box is an inverted "L" shape.

## 3.2. Other parts

**3.2.1. Fuse.** The rated continuous current of the fuse must be less than the rated continuous current of any electrical component protected by it, and its rated breaking current is higher than the theoretical short-circuit current of the high-voltage system protected by it. When selecting the type of fuse, the rated current of the motor and the voltage of the drive system should be considered.

**3.2.2. DC contactors, relays, etc.** The coil voltage, and the rated voltage of the motor, as well as the power, current and other parameters should be considered comprehensively when selecting the model.

## 4. Determining the cooling method of the battery module[4]

According to the classification of the heat transfer medium, the heat dissipation system of the battery pack can be divided into air cooling, liquid cooling and phase change material cooling, or a mixture of multiple cooling methods. Air cooling is divided into two methods: natural convection cooling and forced convection cooling. The battery pack that adopts natural convection heat dissipation method does not need to use the energy of any external auxiliary components. The natural wind generated by the driving of the car will blow through the battery pack and take away the heat

generated by the battery operation. The forced convection method requires the use of external auxiliary components, such as fans or radiators. This method has relatively low requirements for the packaging design of the battery pack itself, and which is suitable for more complex systems, but this type of heat dissipation method is more complicated. In addition, although its heat dissipation efficiency will be higher than natural convection, it will also consume additional energy from the battery pack. The main advantages of the air cooling method are simple structure, light weight, and no leakage, besides the harmful gas can be discharged in time. However, the convection heat transfer coefficient between air and the battery wall is relatively low, and the cooling and heating speed are very slow.

The convection heat transfer coefficient of the liquid cooling method is relatively large, and the cooling speed of the battery is relatively fast. Under the same conditions, the heat dissipation effect is better than air cooling, but this kind of cooling method may cause liquid leakage, the later repair and maintenance are more difficult, and the structure is also more complicated. In addition, the heat exchange rate between the battery wall and the fluid medium is related to the fluid flow pattern, flow velocity, flow rate and fluid density.

Considering the battery power and battery capacity comprehensively, to avoid forced heat dissipation to consume too much battery energy, and at the same time to ensure a relatively good heat dissipation efficiency, it was decided to use liquid cooling for heat dissipation. It is planned to conduct heat conduction between the battery and the aluminum plate, so that the coolant in the inner flow channel between the aluminum plate and the aluminum plate can collectively exchange heat, and take away the heat generated by the battery.

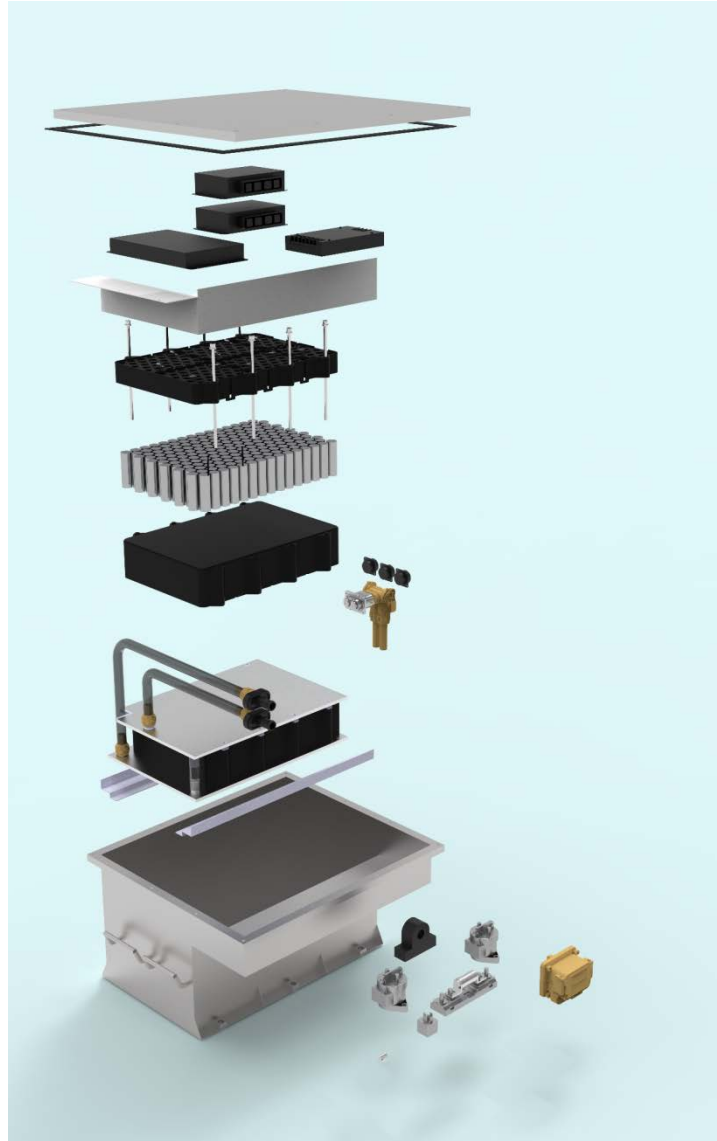

Figure 5. Exploded view of the internal structure of the battery box

## 5. Thermal simulation calculation based on comsol

The thermal behavior of the lithium-ion battery pack plays a vital role in the overall performance of the battery, and the study of the thermal effect of the battery pack is of great significance to the actual production. Based on the comsol[5] simulation platform, a three-dimensional thermal model is established to quantitatively analyze the temperature distribution under 1C and 2C operating current conditions, and the heat dissipation effectiveness of the water cooling system.

### 5.1. Material physical properties

Electrode material: conductivity is  $3.8 S/m$ , diffusion coefficient is  $10^{-14} m^2/S$ , density is  $4140 kg/m^3$ . Electrolyte: density is  $1053 kg/m^3$ , specific volume is  $9.493 \times 10^{-4} m^3/kg$ , pressure is  $0.11 MPa$ , specific heat at  $40^\circ C$  is  $3.358 KJ/(kg \cdot K)$ . The thermal conductivity of thermally conductive adhesive is  $2W/(m \cdot K)$ .

### 5.2. Simulation calculation

Through the parameters such as the power and voltage of the battery pack, the arrangement position of the battery and the structure of the battery pack can be reasonably designed and optimized. Apply comsol software to set up different physical fields, simulate this kind of water cooling method,

determine the effective heat dissipation, and obtain the data of 1C and 2C battery pack discharge temperature changes. (The 1C discharge current is 3600s for the discharge time, and the 2C discharge current is 1800s for the discharge time.)

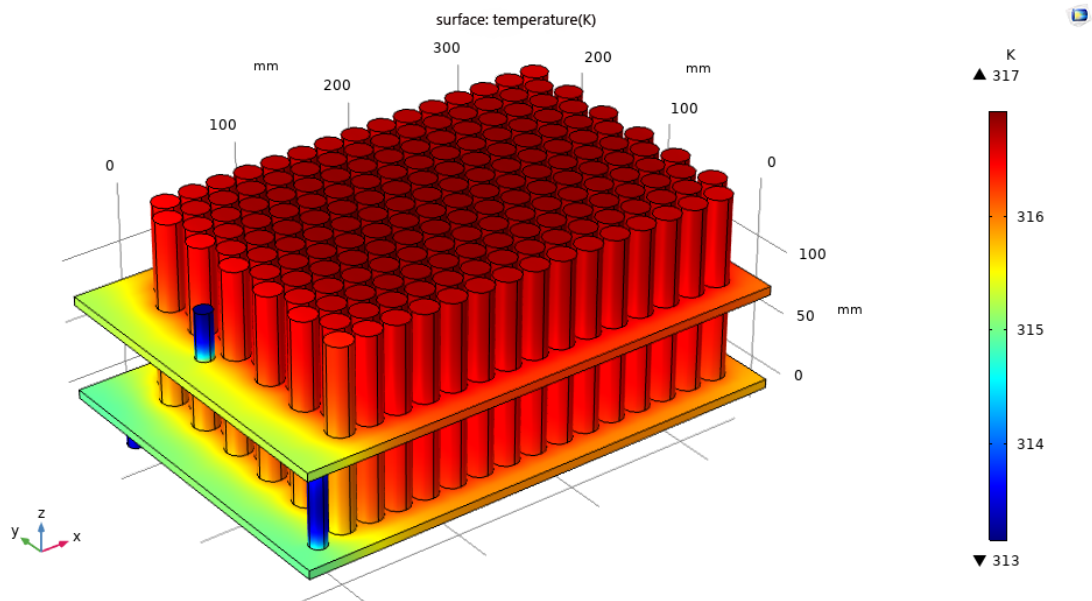

Figure 6. 1C surface temperature distribution map

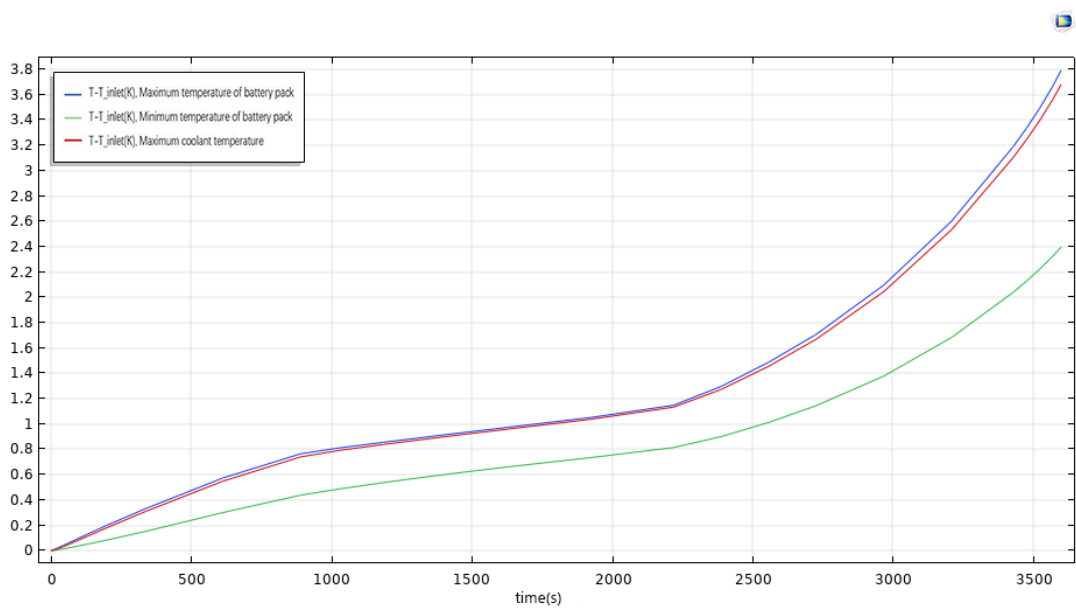

Figure 7. 1C battery pack and coolant temperature change curve

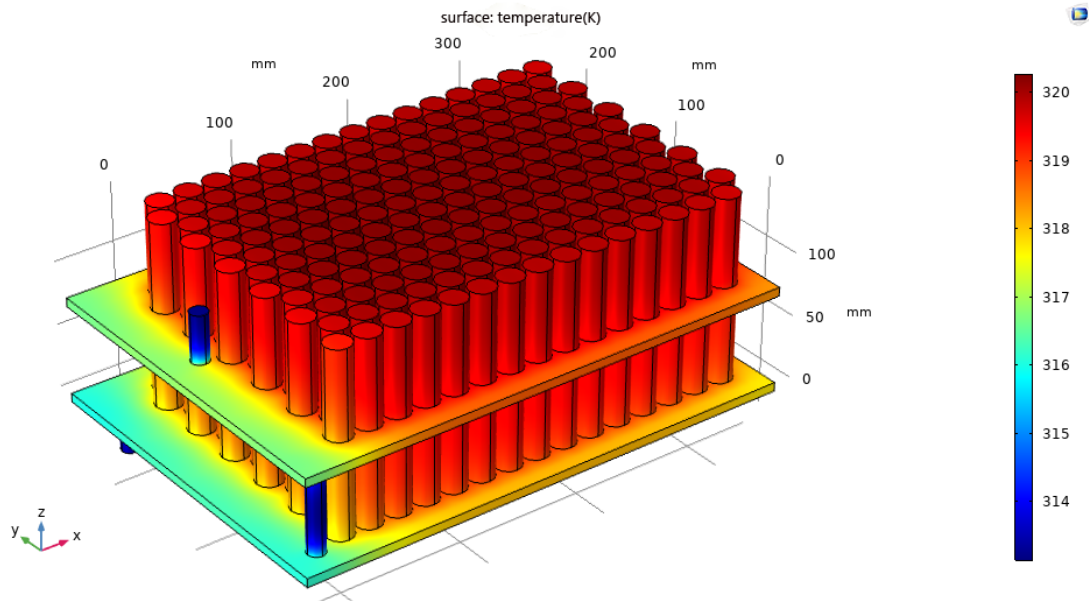

Figure 8. 2C surface temperature distribution map

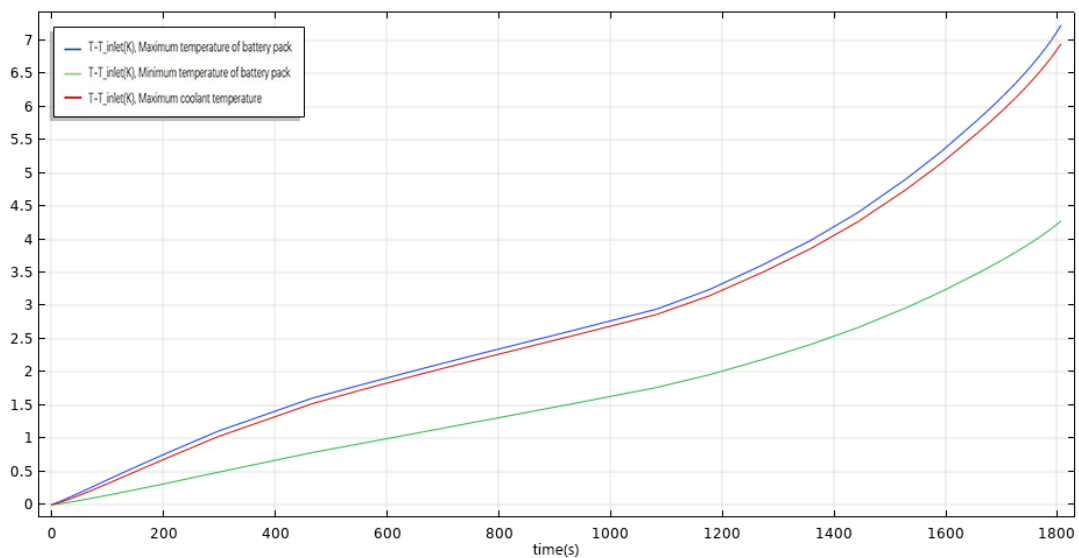

Figure 9. 2C battery pack and coolant temperature change curve

### 5.3. Result analysis

It can be seen from the figure that the module temperature gradually decreases radially from the inside to the outside, and the highest temperature is concentrated in the central area. As the discharge progresses, the temperature inside the battery gradually increases, but the cell temperature is within a controllable range. Under this water-cooling system, both 1C and 2C discharges can make the battery pack work within the normal temperature range, so the battery pack can also work normally under discharge conditions lower than this rate. The water cooling system can ensure that the battery pack always works within the normal temperature range.

## 6. Conclusion

First analyze the design requirements and principles of the battery system, and then select the components to obtain the battery system assembly model. Finally, perform thermal simulation calculations on the battery module and the water cooling system to ensure that the battery is always



within a safe operating temperature range. This article can provide a certain reference for the design of other battery systems.

## References

- [1] LIU Xiao-dong;YUAN Qing. Research and Design of Battery Management System for Electric Vehicles[J]. Auto Electric Parts, 2020(04):14-15.
- [2] Zhang Yanmei. Performance analyse of cylindrical ternary lithium battery for Electric Vehicle[J]. Automobile Applied Technology, 2019,(09):35-38.
- [3] WEN Hong-yan;KUANG Zhong-fu;DING Ming-yi;XIONG Zhi-qi;LU Jin-cheng;ZHOU Jin-zheng;LU Yan-jun. Lithium-ion Power Battery Market Analysis and Technological Progress[J]. Chinese Battery Industry, 2020,24(06):326-329+334.
- [4] Wu Bo. Summary of Thermal Management of Lithium Battery for Electric Vehicle[J]. Automotive Digest, 2020, (11):9-14.
- [5] YE Dan-hong;JIANG Yi-tian;HU Ran;WANG Chao;LUO Chong-xiao. A kind of high-accurate and fast simulation technology for thermal battery[J]. Chinese Journal of Power Sources, 2020,44(04):592-594+612.